



# ELECTRIC RELEASE SINGLE EFFECT COUNTDOWN COUNTERS

## EP4/0



- **4-digit h = 8 mm display**  
white digits on black background
- **materials**  
die-cast zamak body  
ABS casing  
metallic and self-lubricating synthetic  
material internal kinematic motion devices.
- **contact range**  
1 AMP, 24 V CC;
- **speed**  
1,000 strokes/min

 gr. 580

 mm 115 x 95 x 50

### TYPICAL APPLICATIONS

Motorization for knitting machines – electric  
saws – automatic feeding presses.

- 1) Command handle
- 2) Digital display
- 3) Digit releasing key
- 4) Digit presetting button
- 5) Terminals
- 6) M5 threaded holes for counter fixing

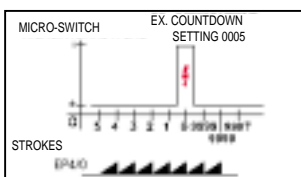
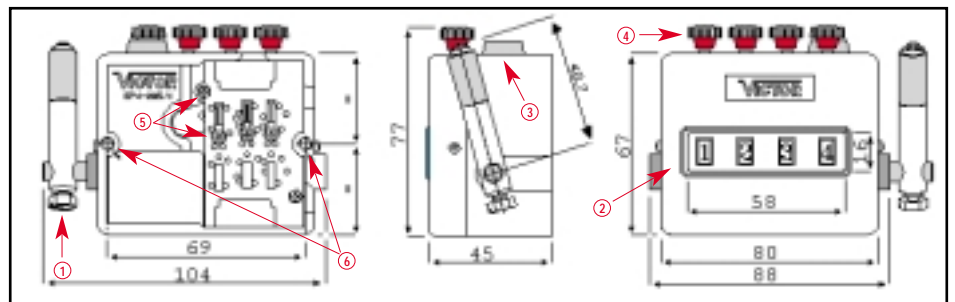

**EP4/0** - Countdown device which can activate a micro-switch upon reaching the zero value.

COD.	MOD.	SHAFT OUTPUT	ROTATION
FC0285/003	EP4/0	right	right

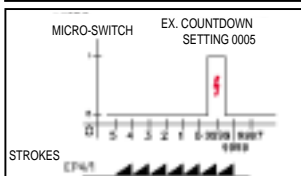

**EP4/1 (Variant)** – Countdown device which activates the micro-switch one unit after reaching the zero value (or 9999).

COD.	MOD.	SHAFT OUTPUT	ROTATION
FC0285/103	EP4/1	right	right

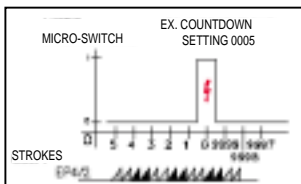

**EP4/2 (Variant)** – Progressive countdown device of alternate blows number (full point).

COD.	MOD.	SHAFT OUTPUT	ROTATION
FC0285/203	EP4/2	right	right

### OPERATION INSTRUCTION

TO PRESET THE DESIRED VALUE ON THE DISPLAY, COMPLETELY PUSH DOWN THE 3 KEY SO THAT IT STAYS DOWN - THIS WAY THE DIGITS REMAIN INDEPENDENT FROM EACH OTHER. COMPOSE THE DESIRED VALUE BY SELECTING EACH DIGIT BY MEANS OF THE 4 KEYS. WHEN PUSHING DOWN THE COMMAND HANDLE FOR THE FIRST TIME, ONCE THE 0 VALUE (OR 9999 DEPENDING ON THE VERSION) IS REACHED, THE DEVICE STARTS THE COUNTDOWN AND, UPON REACHING 0 (OR 9999 DEPENDING ON THE VERSION), A MICRO-SWITCH IS ACTIVATED TO STOP THE OPERATING MACHINE OR TURN ON ONE OF THE LEDS, ACCORDING TO THE USER'S CHOICE. AFTER THE MICRO-SWITCH RELEASE, THE DEVICE MUST BE PRESET AGAIN AS BEFORE. THE DEVICE HAS NO QUICK RESET.

PROGRAMMERS

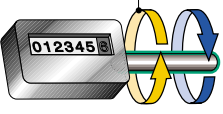
ROTATION RIGHT	CODE INDICATION		
	model	shaft output	shaft rotation
	<b>example of order</b>	EP4/0	D
	<b>description</b>	right	right

